



P4 Pellet



Heating with pellets

For more than 50 years Froling has specialised in the efficient use of wood as a source of energy. Today the name Froling stands for modern biomass heating technology. Froling firewood, wood chip and pellet boilers are successfully in operation all over Europe. All of our products are manufactured in our factories in Austria and Germany. Our extensive service network guarantees full coverage and reliability.



froling

Make savings with pellets without compromising on comfort

The price changes for different energy sources in recent years show the benefits of wood pellets: the ecological way of heating is also economically attractive. Wood is a renewable energy source that is also CO₂-neutral. Pellets are made of natural wood. The large volumes of wood shavings and sawdust

generated by the wood-processing industry are compacted and pelleted without being treated beforehand. Pellets have a high energy output and are easy to deliver and store.

These are just some of the advantages that make pellets the perfect fuel for fully automatic heating systems. Pellets are delivered by tanker and unloaded directly into your store.



The next generation of pellet boilers

Froeling has set new international standards for technology and design with the new P4 Pellet. With its ingenious fully automatic operation, this new product from Froeling offers the ultimate in convenience.



Multi-award winning products

AUSTRIAN ECOLABEL - Awards for quality and safety

The Froling P4 Pellet boiler has won many international quality awards in Europe and the USA. Probably the most prestigious of all is the Austrian Ecolabel, describing itself as the world's first environmental award for products and services.

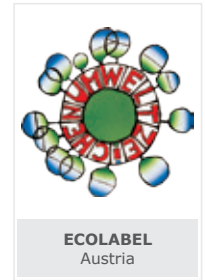

Modern biomass boilers are future-oriented and economical. This is also guaranteed by the many international standards on emissions and efficiency. In Austria the limit values are set by Article 15a of the Federal Constitution (B-VG) and in Germany they are set by the Federal Emissions Control Act passed at the start of 2010 (and implemented in the Federal Emissions Control Ordinance (BImSchV)).



VESTA Award
USA



Innovation Award at "Bois Energie" 2008
France



New Product of the Show Award
Ireland



Plus X Award
International



From low-energy houses to apartment blocks

When it comes to determining heating requirements, the heated living space and the type of construction are the most important factors. The P4 Pellet is available in ten different sizes, and with its wide output range and modulating operation it can be used in both low-energy houses and in buildings with greater heating requirements. It can also be connected to an existing heating system. The Froling Lambdatronic P 3200 smart control management system takes charge of all control functions, including remote control via PC or mobile phone.

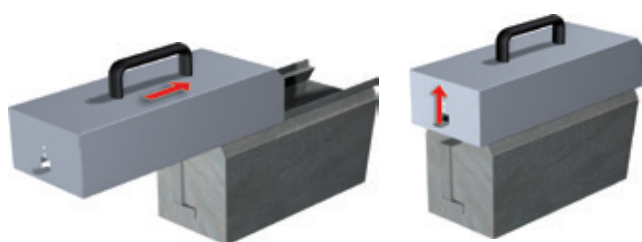
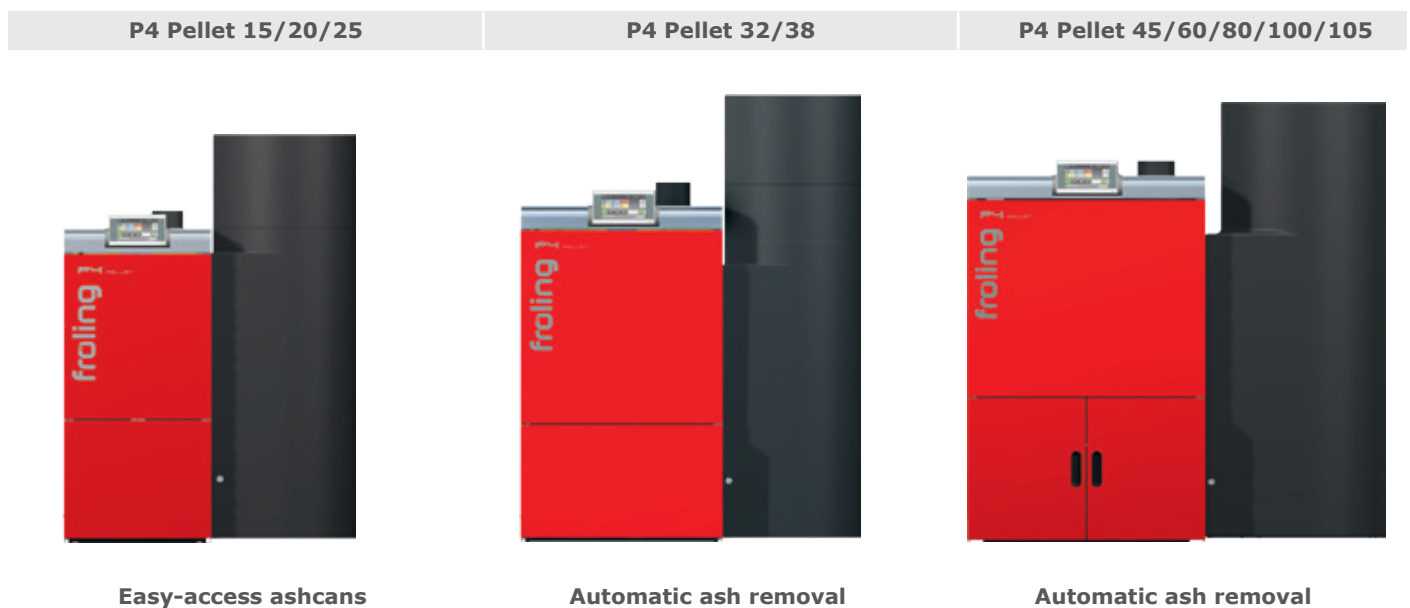

Easy-access ashcan (P4 15-25)

With this user-friendly ash removal system the ash is automatically fed into two ashcans. With the transport cover in place, the ashcan can simply be carried to the emptying point for dust-free disposal.

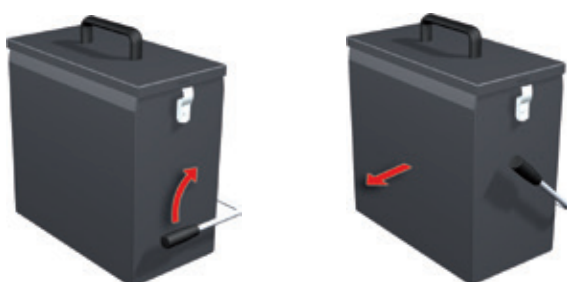

Automatic ash removal (P4 32 onwards)

With automatic ash removal the ash is fed into two external ash containers. The clever locking mechanism makes it quick and easy to remove the ash container.

The latest technology

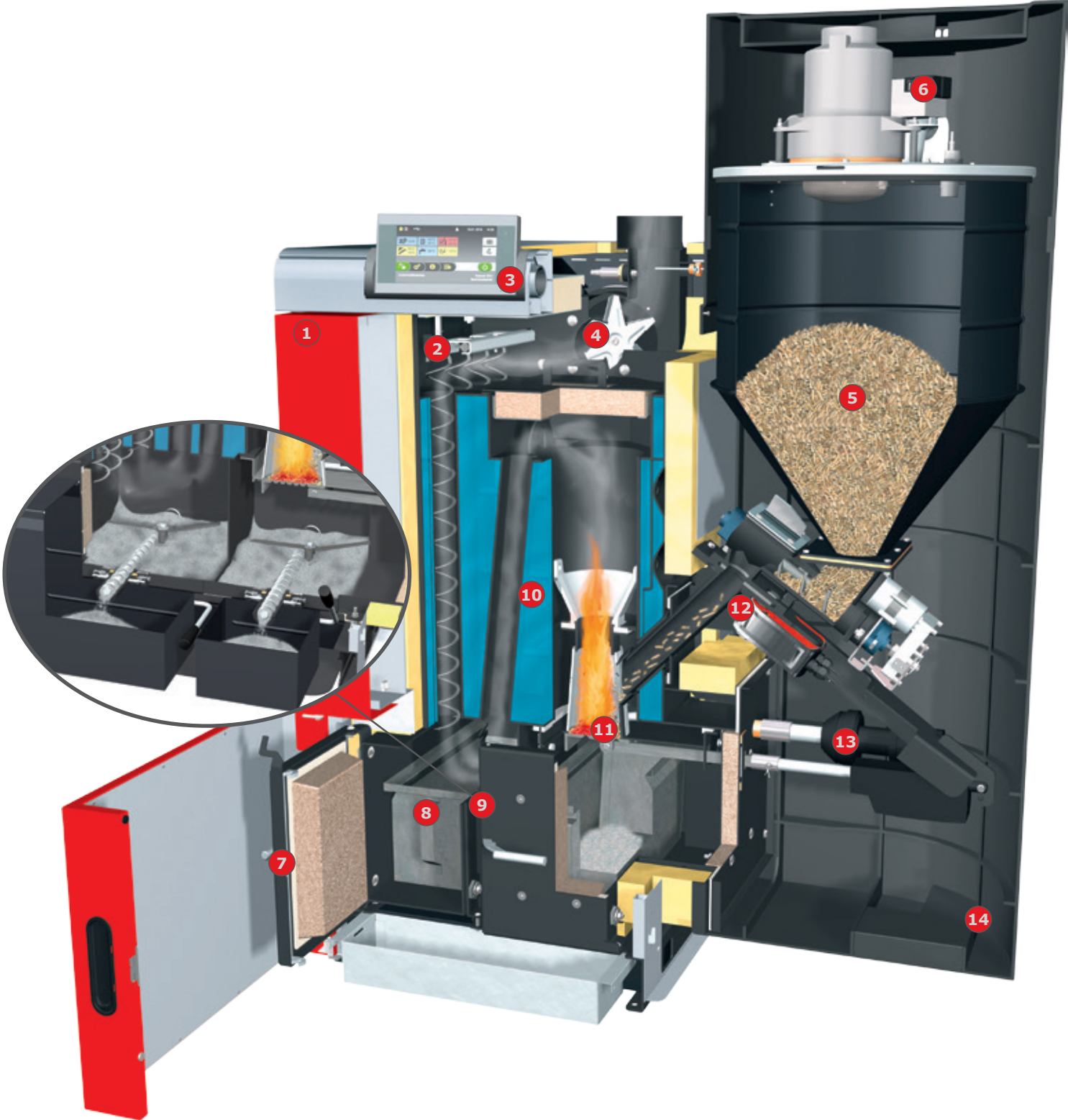



The new pellet boiler with special benefits:

- 1 Multi-layer insulation for the highest level of thermal insulation.
- 2 WOS technology (efficiency optimisation system) as standard for maximum efficiency and automatic heat exchanger cleaning.
- 3 Lambdatronic P 3200 control with 7" touch display and innovative bus technology.
- 4 Speed-regulated, low-noise induced draught fan with function monitoring for maximum operational reliability.
- 5 Large pellet container with automatic pellet feed and integrated soundproofing (volume 90 - 280 litres).
- 6 Store gate valve.
- 7 Insulated cleaning port door for excellent heat retention.
- 8 Large easy-access ashcan with P4 Pellet 15 - 25.
- 9 Automatic ash removal in two closed ash containers with P4 Pellet 32 - 105.
- 10 Patented multiple-pass heat exchanger for variable boiler operation, ideal for heating low-energy houses. The 3-pass heat exchanger design guarantees the best possible ash separation. It also avoids the need for an external return temperature control.
- 11 Automatic sliding grate for ash removal, offering maintenance-free operation.
- 12 Proven burner gate valve.
- 13 Automatic ignition with hot-air blower.
- 14 Special suction cyclone with integrated soundproofing for almost silent operation.

Perfection in the details



Smart positioning and installation

Feature: Plug and play

- Advantages:
- Unpack, connect, heat
 - Compact design
 - Easy positioning

The P4 Pellet offers important advantages even before it reaches your boiler room. Its compact design makes it child's play to install the P4 Pellet even in confined spaces. All components are already fully wired. But if necessary, individual components can be removed in just a few steps. The parts can then be positioned separately. This means that the P4 Pellet is also an excellent choice for renovated systems.



Feature: Multi-layer heat exchanger with 3-pass design

- Advantages:
- Maximum boiler use
 - Considerable cost savings
 - Long service life

The patented multiple-pass heat exchanger means that operation is perfectly adjusted in every respect with the P4 Pellet. An external return temperature control is not necessary. Together with the variable operation, this results in considerable operating savings. The special boiler construction prevents the temperature from dropping below the dew point and ensures the P4 Pellet has a very long service life. The 3-pass design repeatedly alters the flow of the flue gases in the boiler, ensuring exceptionally efficient ash separation.

Feature: Easy to clean

- Advantages:
- Clean combustion
 - Very low emissions
 - Automatic ash removal

With the P4 Pellet you are choosing a quality product. The automatic sliding grate allows for convenient and maintenance-free operation. Ash is always generated when wood or pellets are burnt. In the P4 Pellet it is transported automatically to two ash containers, which can be emptied simply and easily.

Feature: Energy efficiency

- Advantages:
- Low energy consumption
 - Low operating costs

Particular attention was paid to energy efficiency during the development of the P4 Pellet. This priority was clearly confirmed when the boiler was awarded the Blue Angel and the Austrian Ecolabel. The P4 Pellet consumes little energy during operation, keeping the operating costs down.

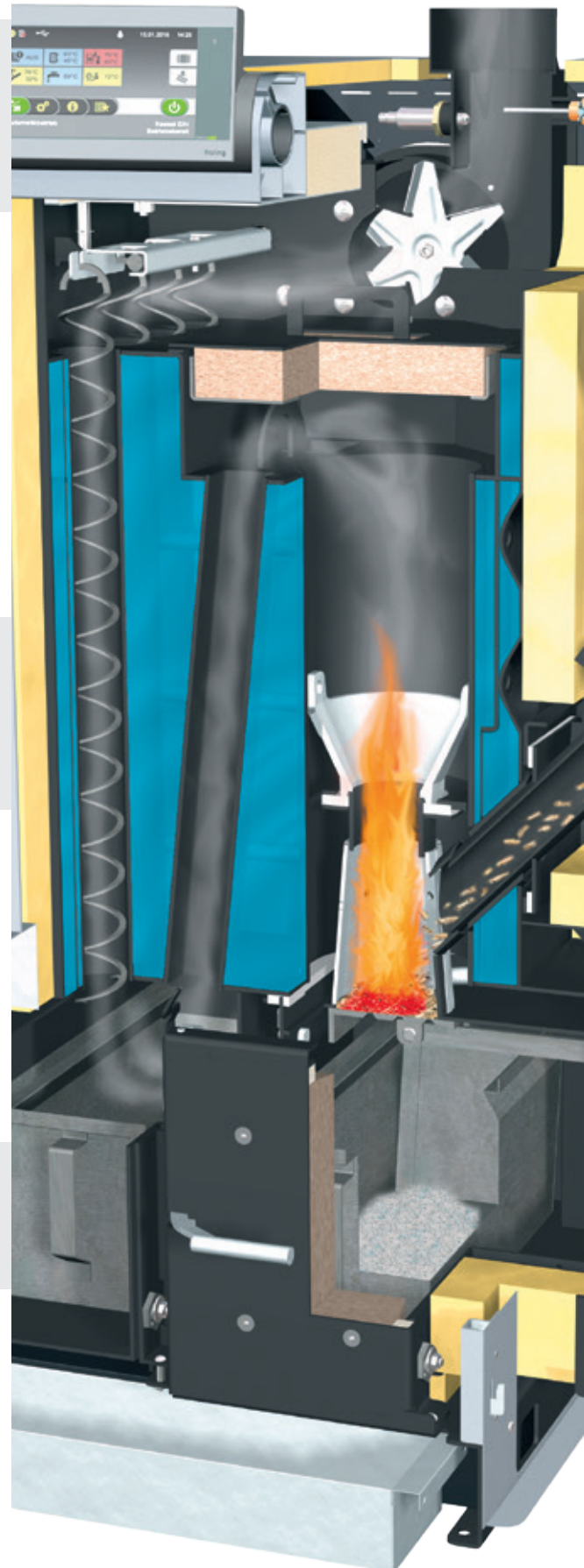

Perfection in the details

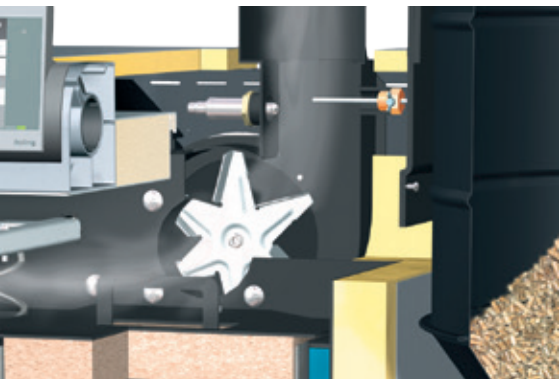

Feature: **Speed-regulated induced draught fan and lambda control**

- Advantages:
- Maximum ease of use
 - Constant optimisation of combustion

The speed-regulated induced draught fan, which comes as standard, ensures the exact air quantity for combustion. In conjunction with the broadband lambda probe it creates optimum combustion conditions.

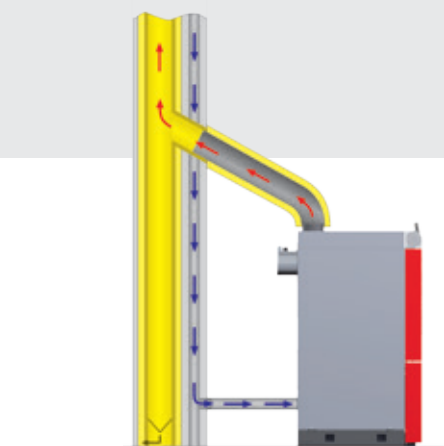

Feature: **Room-air-independent operation**

- Advantages:
- Perfectly suited for low-energy houses
 - The highest possible system efficiency

Low-energy houses have a closed building shell. In traditional boiler rooms there can be uncontrolled heat loss from the necessary ventilation openings. This is avoided with room air-independent boilers because of the direct air connection. Also the temperature of the combustion air that is supplied is raised with an integrated pre-heating system, increasing the efficiency of the boiler.



Feature: **Comprehensive safety concept**

- Advantages:
- The highest possible operating safety
 - Maximum reliability

The downpipe – in conjunction with the safety-tested, gate valve-fitted combustion chamber and the gate valve-fitted store – creates a double door system. The self test before the system starts and the automatic diagnostics system support this unique safety concept.

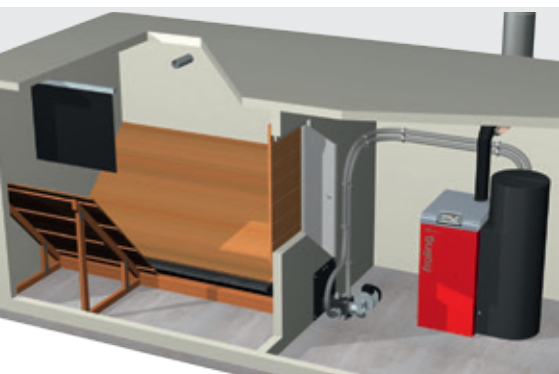

Feature: **Also ideal for container installation**

- Advantages:
- Relocation of the boiler room and store
 - All-in-one system
 - Perfectly matched components

The Froling Energy box is an all-in-one complete solution. All components are perfectly matched to each other.

Option: Condensing boiler technology



For outputs from 15 to 60 kW, the Froling P4 Pellet boiler is also available with innovative condensing boiler technology. The flue gas contains energy, which escapes unused up the chimney with conventional solutions, but an additional heat exchanger positioned on the back of the boiler makes use of it for the heating system. This increases the **boiler efficiency to over 104 percent (HU)**. Froling won the innovation prize at the ExpoEnergy trade fair in Wels for condensing boiler technology in the biomass sector as early as 1996, making it a pioneer in the field.

The heat exchanger is made of high-quality stainless steel. It is cleaned using a water flushing system. The module can also be retrofitted.

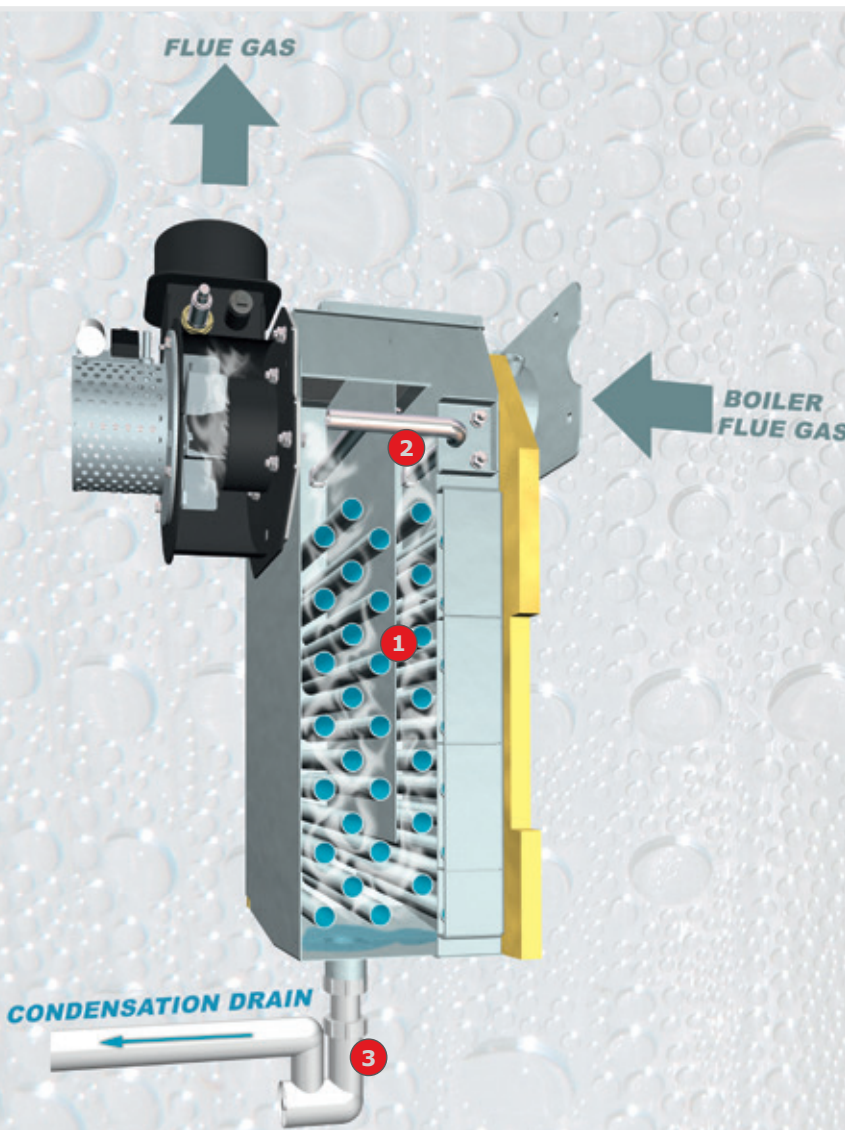

Overview of condensing boiler heat exchanger:

- 1 Stainless steel heat exchanger
- 2 Automatic flushing equipment
- 3 Drain with siphon to remove condensation

Requirements for optimal use of condensing boiler technology:

- The lowest possible return temperature (e.g. floor or wall heating)
- Moisture-resistant and soot fire-resistant flue gas system
- Duct connection for drainage of condensation and flushing water

Feed systems

RS 4 / RS 8 pellet suction system

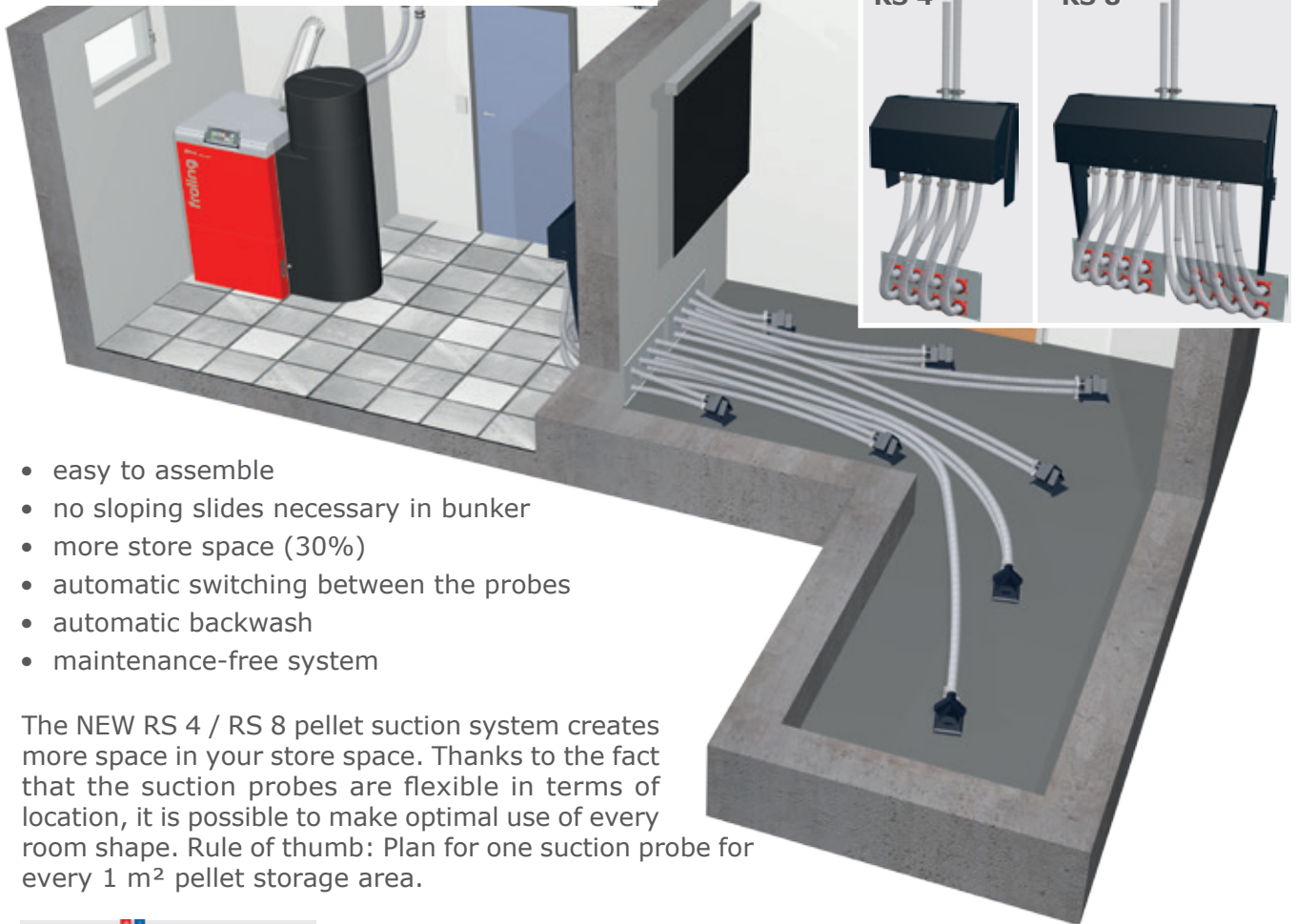

- easy to assemble
- no sloping slides necessary in bunker
- more store space (30%)
- automatic switching between the probes
- automatic backwash
- maintenance-free system

The NEW RS 4 / RS 8 pellet suction system creates more space in your store space. Thanks to the fact that the suction probes are flexible in terms of location, it is possible to make optimal use of every room shape. Rule of thumb: Plan for one suction probe for every 1 m² pellet storage area.

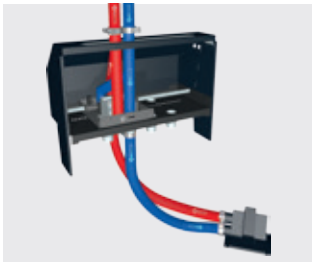

It automatically selects 4 or 8 suction probes in specified cycles, it is controlled by the pellet boiler. If, however, the suction probe fails unexpectedly, it is remedied by a **fully automatic reversal of the air flow (backwash)**.

Depiction: fully automatic reversal of flow

4 times suction system manual

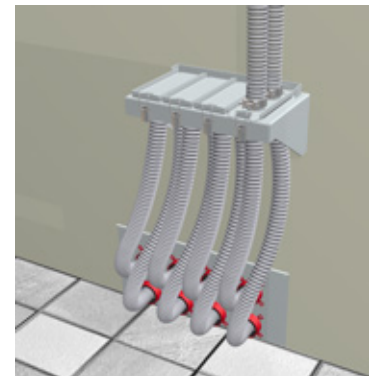
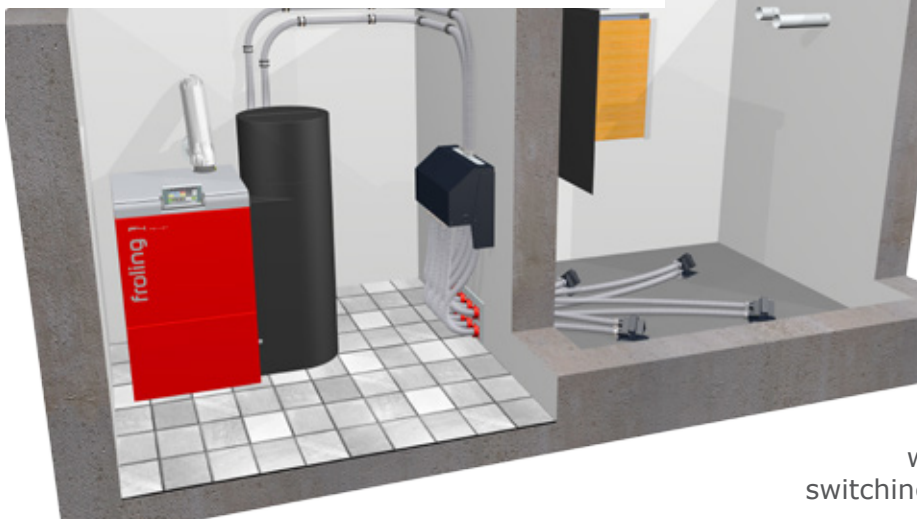

Same as above but with the difference of the manual switching between the suction systems.

Suction screw system

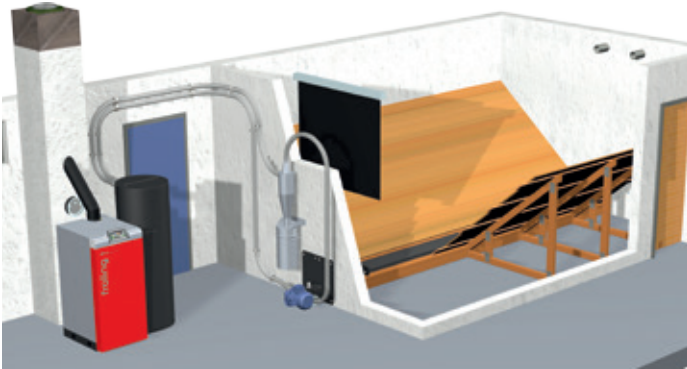

The Froling suction screw system is the ideal solution for rectangular rooms with front-end removal.

The deep and horizontal position of the discharge screw means the space in the room is used optimally and complete emptying of the store is guaranteed. Combined with a suction system from Froling it also enables flexible boiler setup.

1-2-3 suction screw system

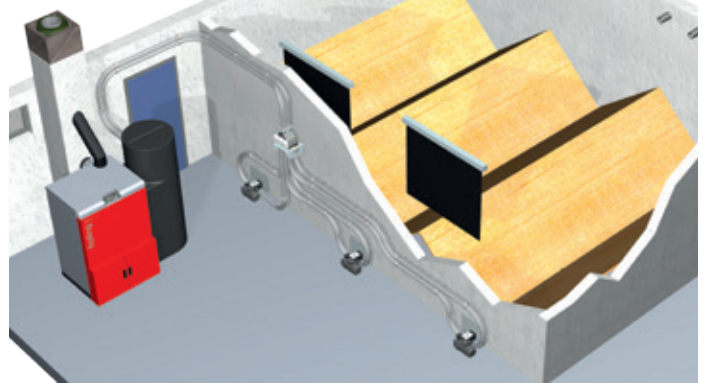

The 1-2-3 suction screw system from Froling is the ideal solution for large stores.

Depending on the size of the store, two or three discharge screws are positioned parallel to each other and integrated into the fuel feed of the suction system. The automatic screw selector automatically switches between the suction screws in a predefined cycle, ensuring that the store is emptied evenly.



Pellet filling pipes

The pellets are delivered by tanker and blown into the store through a filling pipe. The second pipe is used for controlled and dust free removal of the escaping air.

Bag silo discharge system

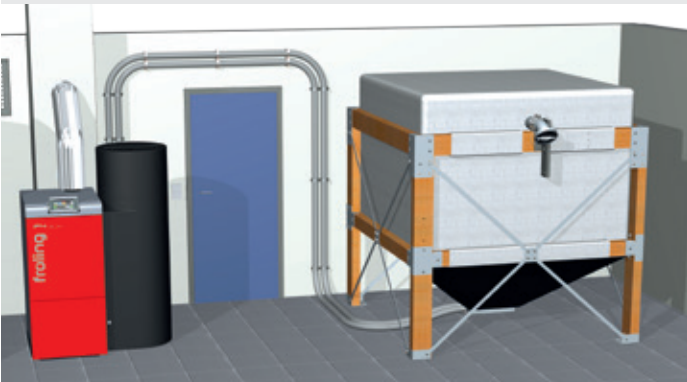

The bag silo system is a flexible, simple way of storing pellets. Available in 9 different footprints (from 1.5 m x 1.25 m to 2.9 m x 2.9 m) with a capacity of between 1.6 and 7.4 tonnes, depending on the bulk density.

Using a bag silo brings other benefits: it is simple to assemble and, if necessary, it can be installed outside with the necessary protection against rain and UV light.

Pellet Mole®



This pellet discharge system is easy to install and makes full use of the store space.

The Pellet Mole® draws the pellets from above, ensuring an optimum fuel feed to the boiler. The Pellet Mole moves automatically into every corner of the store to empty it as efficiently as possible.

System convenience

Option: Fuel tuning with the PST pellet deduster



Wood pellets are clean and of very high quality. Any remaining wood dust can be filtered from the fuel using the PST pellet deduster. This optimises the efficiency of the combustion zone over the years. The PST pellet deduster can be fitted in any position in the return air line of the pellet suction system.

The suction cyclone design means that the dust particles are separated from the return air and deposited internally. The container is convenient to remove and transport to the emptying point. The system can be retrofitted at any time and it is maintenance-free.



Supply bin

If it is not possible to set up a fuel store, a supply bin is the perfect alternative. Thanks to the modular design an automatic feed system can be retrofitted later at any time.

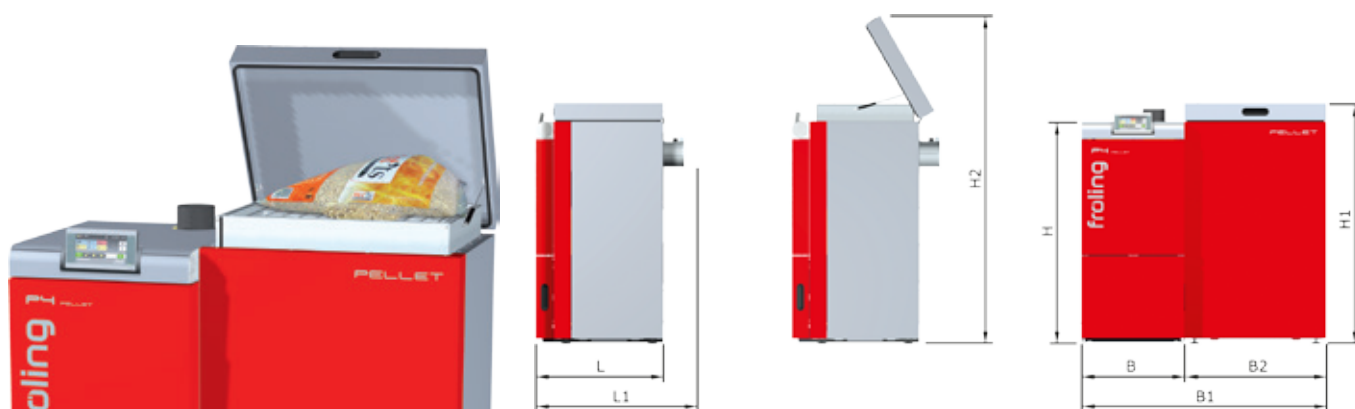

Dimensions and data			P4 Pellet 15	P4 Pellet 20	P4 Pellet 25
L	Length of boiler	[mm]	740	740	740
L1	Length including induced draught fan	[mm]	940	940	940
B	Width of boiler	[mm]	600	770	770
B1	Width including supply bin	[mm]	1425	1595	1595
B2	Width of supply bin	[mm]	825	825	825
H	Height of boiler	[mm]	1280	1280	1280
H1	Height of supply bin	[mm]	1400	1400	1400
H2	Height of supply bin when open	[mm]	1890	1890	1890
	Capacity	[l]	235	235	235
	Total weight including boiler	[kg]	406	470	480

Lambdatronic P 3200 control

With the new Lambdatronic P 3200 boiler controller, Froling is taking a step into the future. The control unit is optimised to suit any requirement. An individually adjustable viewing angle ensures that all operating statuses are clearly displayed. Exact combustion control thanks to lambda control **with broadband probe** as standard. The menu structure is ideally organised to ensure easy operation. All essential functions can be selected by simply pressing a button.



Lambdatronic P 3200 control

Advantages:

- Exact combustion control with broadband probe lambda control
- Large, clear control unit

NEW! 7" Touch-Display

Advantages:

- Individual installation of your own heating system
- Even more comfortable operation of the boiler thanks to a larger touch screen

Accessories for even greater ease of use



FRA room temperature sensor

By using the Froling FRA room temperature sensor (measuring only 8x8 cm), the main modes of the corresponding heating circuit can be easily selected and adjusted. The FRA room temperature sensor can be connected with or without affecting the room area. The adjusting wheel allows you to change the room temperature by up to $\pm 3^{\circ}\text{C}$.

RBG 3200 room console

The RBG 3200 room console makes the system even easier to use. The heating system is conveniently controlled from your living room. All important system data is clearly displayed on the 19x8 cm console and settings can be changed at the push of a button.



RBG 3200 Touch room console

The RBG 3200 Touch has an impressive touchpad interface. The menu structure means it is intuitive and easy to use. The 17x10 cm console with colour screen shows the most important functions at a glance and automatically adjusts the background lighting to the conditions. The room consoles are connected to the boiler controller using a bus cable.



System convenience

Online controller
froeling-connect.com



Froling's new online control, froeling-connect.com, allows you to check and control your Froling boiler with boiler touchscreen anytime, anywhere. You can read or modify the main status information and settings easily and conveniently online (from your PC, smartphone, tablet PC, etc.). You can also specify which status messages you would like to receive by text message or e-mail. The new froeling-connect.com service allows the owner of the heating system to enable additional users - for example the installer, a neighbour, etc. - to access the boiler and monitor the heating system, during holidays for instance.



Individual access rights

Customer
Installer
Customer service



Platform-independent
Operate the heating system online



System requirements:

- Froling boiler (core module software version V54.04, B05.09) with boiler touchscreen (software version V60.01, B01.20)
- broadband internet connection
- Froling boiler internet connection via network
- web-enabled terminal device (smartphone/tablet PC/laptop/PC) with web browser

Feature: Systems engineering for optimum energy consumption

- Advantages:
- Complete solutions for all requirements
 - The components work perfectly together
 - Integrated solar power

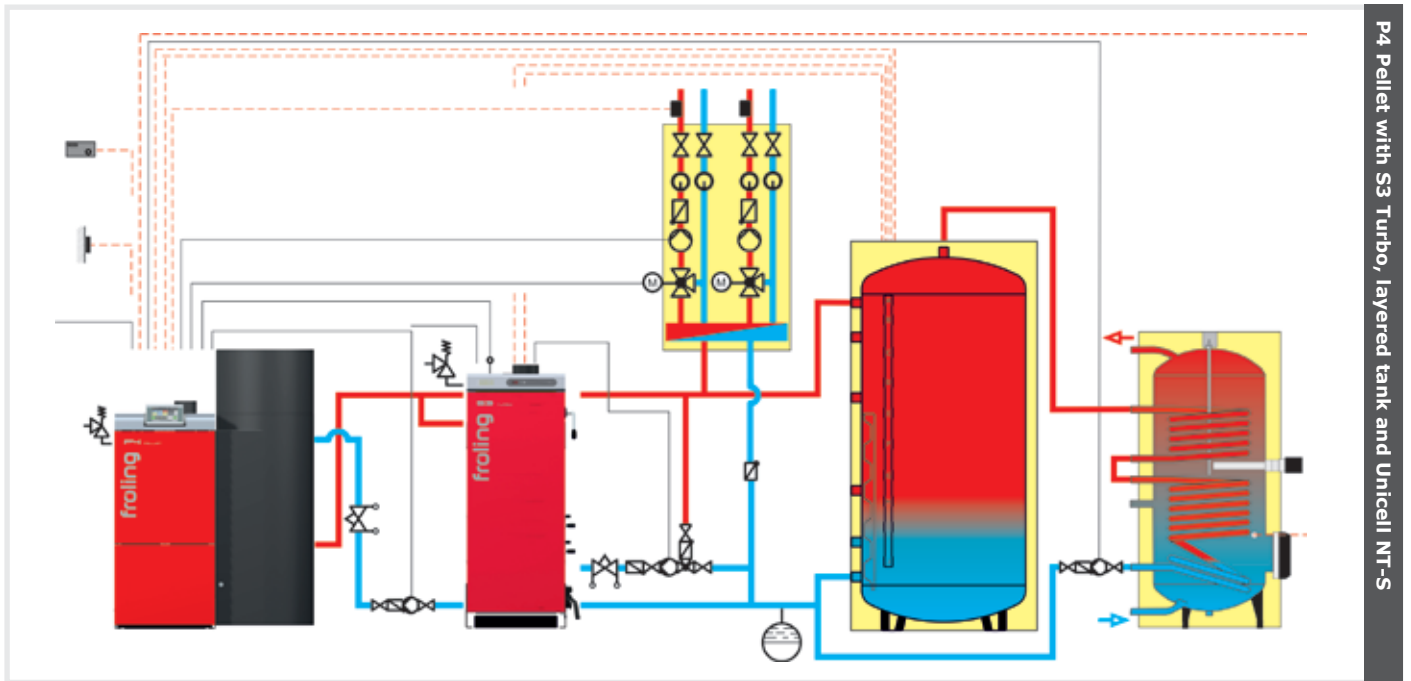

P4 Pellet with S3 Turbo, layered tank and Unicell NT-S

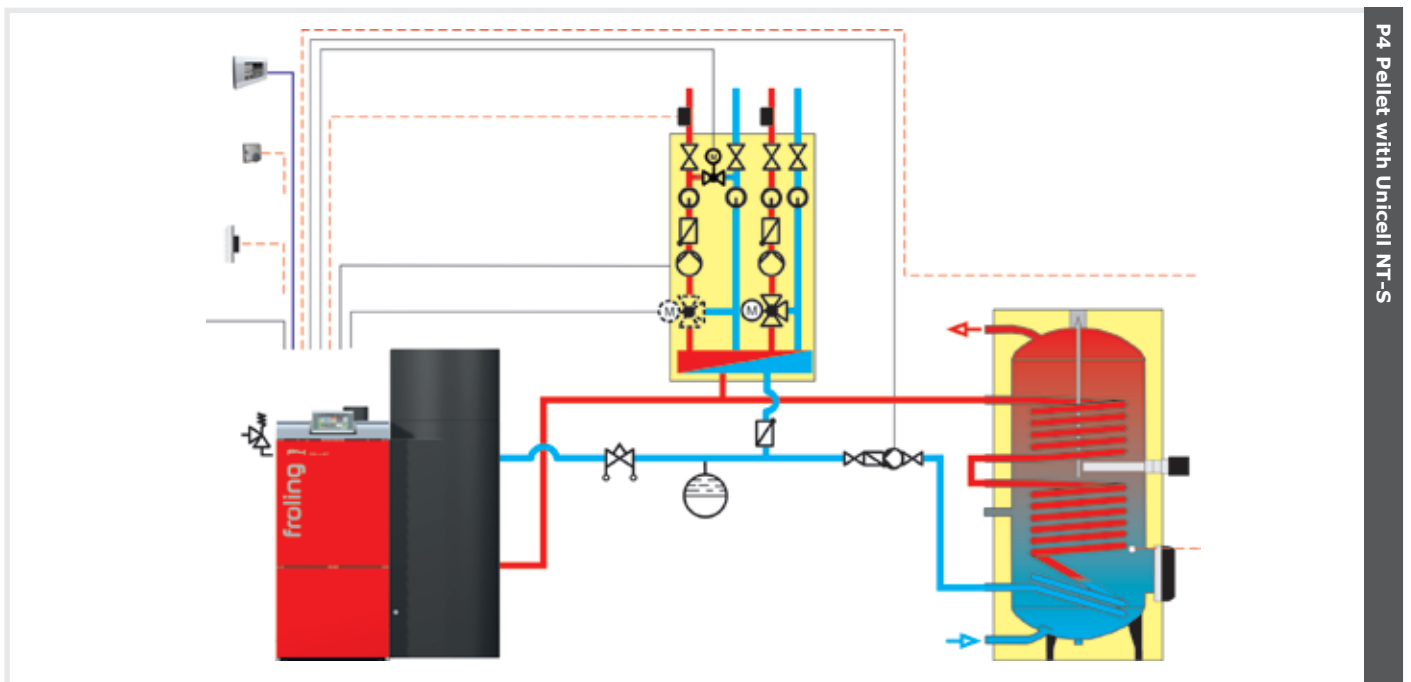

P4 Pellet with Unicell NT-S

Froeling systems engineering offers efficient energy management. Up to 4 storage tanks, up to 8 hot water tanks and up to 18 heating circuits can be integrated into the heating management system.

Perfect connections

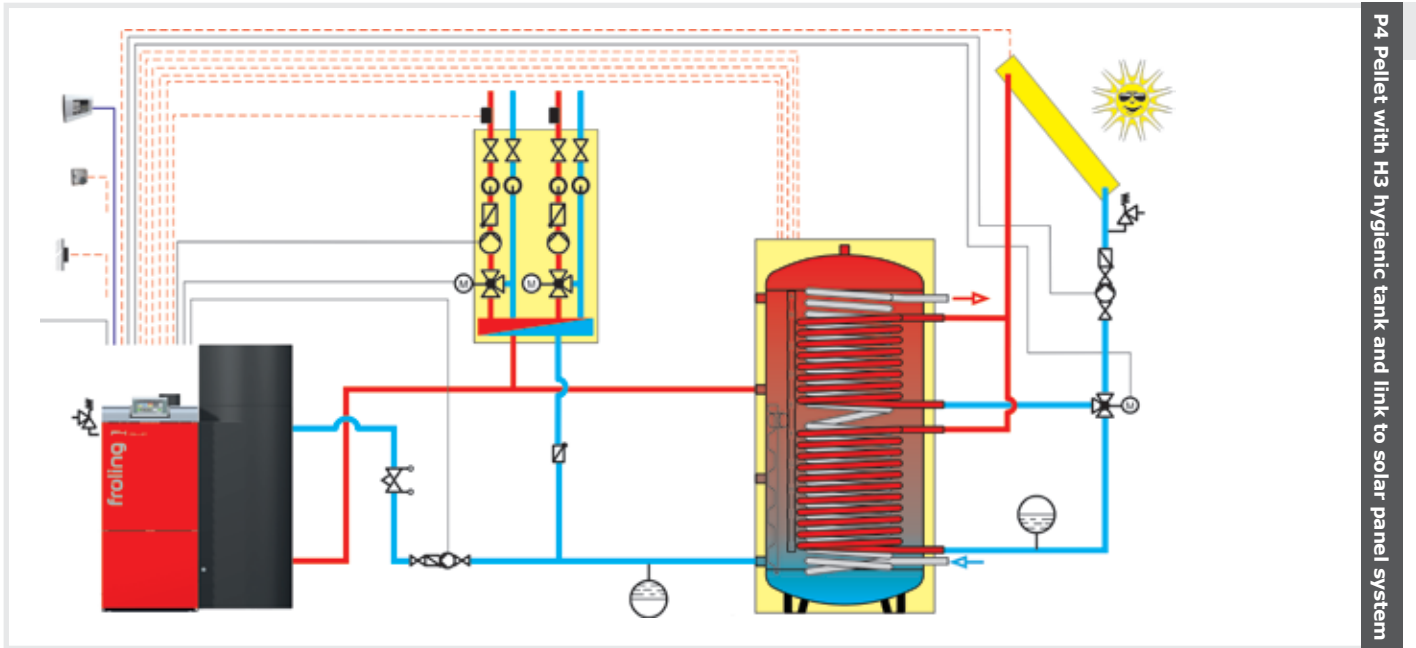

P4 Pellet with H3 hygienic tank and link to solar panel system

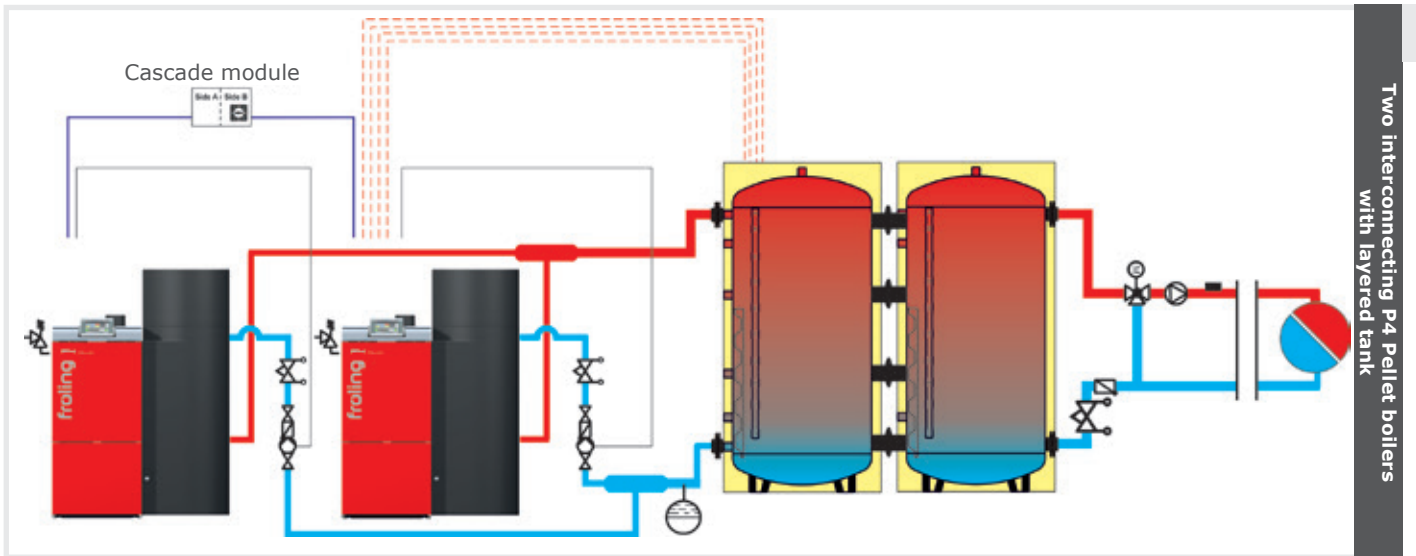

Two interconnecting P4 Pellet boilers with layered tank

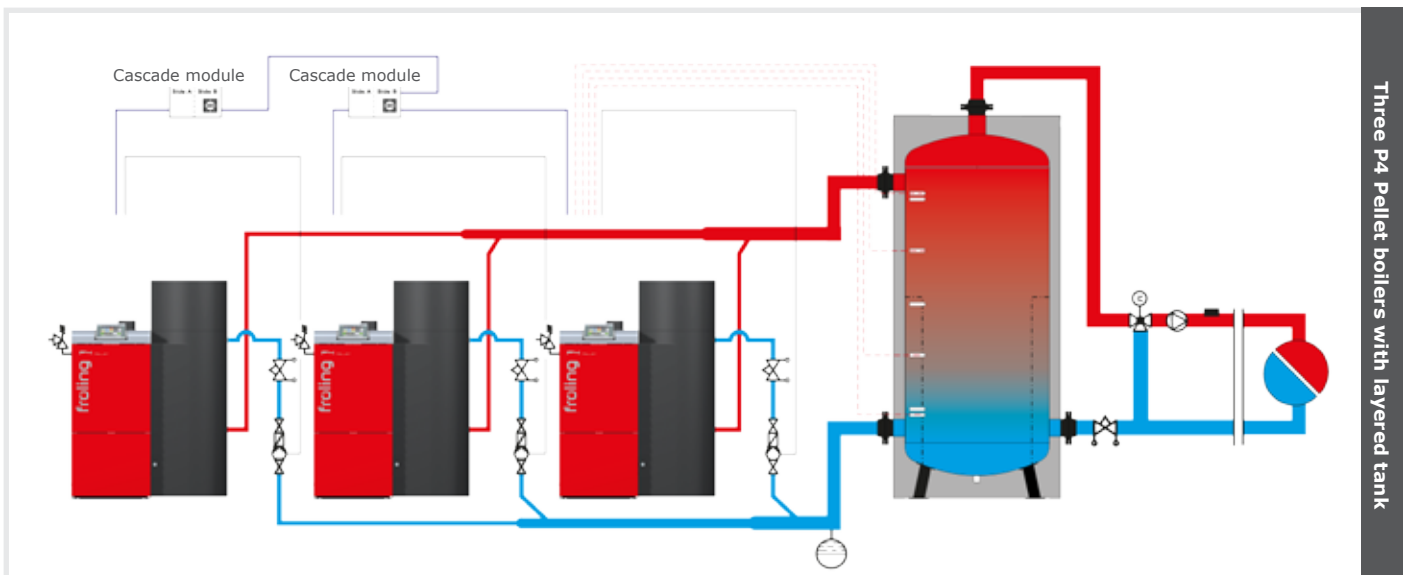

Three P4 Pellet boilers with layered tank

WMZ solar package (optional)

The heat quantity measurement package (WMZ) enables you to benchmark the efficiency of your solar panel system. The Lambdatronic P3200 analyses and displays the flow and return temperature, the flow rate and the daily and total output of the solar panel system.

Variable operation

With variable operation the Froling P4 Pellet is only heated to the temperature level required by the heating system (hot water tank, radiator heating circuit). This avoids unnecessary radiant heat loss. This special feature guarantees maximum efficiency and avoids the need for an external return temperature control.

- Advantages:
- Minimal radiant heat loss
 - Maximum efficiency
 - No external return temperature control required

NEW: Froling cascade controller

Heating requirements vary considerably, especially in larger buildings such as hotels or public buildings. Froling offers a flexible answer to this problem in the form of a cascade. This smart solution allows you to combine up to four P4 Pellet boilers to reach a total output of up to 420 kW. You can also see the benefits of a cascade during the summer months. If the heat requirement is low, one boiler is often sufficient for hot water preparation. This provides a particularly efficient and economical heating solution. A further advantage is the increased reliability of operation, as the heat is provided by several boilers.

Recommended clearances in the boiler room

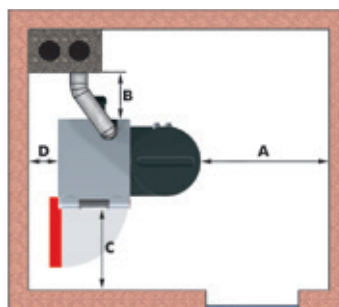

P4 Pellet

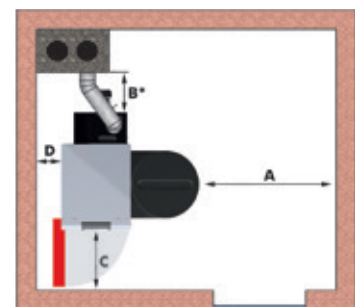

P4 Pellet with calorific value heat exchanger

Mindestabstände im Heizraum - P4 Pellet	8 - 15	20 - 25	32 - 38	45 - 60	70 - 105
A Minimum distance to stoker assembly	300	300	300	300	300
B Induced draught fan maintenance area	300	300	300	300	300
B* Space required incl. maintenance area for induced draught fan with calorific value heat exchanger	300	350	450	450	-
C Space for insulated door	550	720	830	490	590
Space requirement with plug-in insulated door	400	400	300	-	-
D Minimum distance to side of boiler	200	200	200	200	200

All information in mm.

Technical data

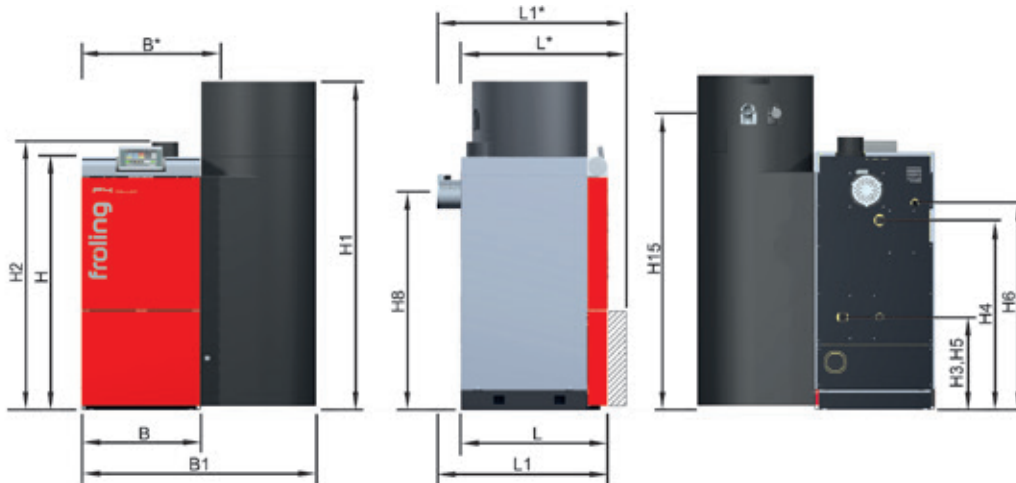

Dimensions - P4 Pellet [mm]	P4 15	P4 20	P4 25	P4 32	P4 38	P4 45	P4 60	P4 80	P4 100	P4 105
L Length of boiler ¹⁾	740	740	740							
L* Length of boiler ¹⁾				820	820	900	900	1000	1000	1000
L1 Total length including induced draught fan	860	860	860							
L1* Total length including induced draught fan				940	940	1020	1020	1070	1070	1070
B Width of boiler	600	770	770	860	860	1030	1030	1235	1235	1235
B* Width of boiler including support ²⁾	705	875	875	965	965	1275	1275	1480	1480	1480
B1 Total width including suction cyclone	1185	1355	1355	1445	1445	1790	1790	2085	2085	2085
H Height of boiler ³⁾	1280	1280	1280	1430	1430	1585	1585	1710	1710	1710
H1 Total height including suction cyclone	1660	1660	1660	1900	1900	1900	1900	1900	1900	1900
H2 Height of flue pipe connection	1350	1350	1350	1530	1530	1685	1685	1785	1785	1785
H3 Height of flow connection (to 38 kW)	460	460	460	460	460					
H4 Height of return connection (to 38 kW)	940	955	955	1085	1085					
H3 Height of flow connection (from 45 kW)						515	515	520	520	520
H4 Height of return connection (from 45 kW)						1290	1290	1410	1410	1410
H5 Height of drainage connection	460	460	460	460	460	490	490	500	500	500
H6 Height of ventilation connection	1030	1030	1030	1155	1155	1310	1310	1430	1430	1430
H8 Height of induced draught fan connection	1090	1090	1090	1215	1215	1375	1375	1495	1495	1495
H15 Height of suction system connection	1480	1480	1480	1720	1720	1720	1720	1720	1720	1720
Flue pipe diameter	130	130	130	150	150	150	150	200	200	200

1) All boilers can fit through an 88 cm-wide doorway.

2) Width of boiler including support for positioning unit. Corresponds to the minimum positioning width after removing the stoker assembly, suction cyclone and stoker unit.

3) Corresponds to the minimum positioning height after removing the stoker assembly, suction cyclone and stoker unit.

Technical specifications - P4 Pellet	P4 15	P4 20	P4 25	P4 32	P4 38	P4 45	P4 60	P4 80	P4 100	P4 105
Rated heat output [kW]	14,9	20	25	32	38	45	58,5	80	100	105
Output range [kW]	3,1-14,9	6,0-20,0	7,5-25,0	8,9-32,0	8,9-38,0	13,5-45,0	17,3-58,5	24-80	24-100	24-105
Energy (ErP) label*	A*	A*	A**	A**	A**	A*	A*	A**	A**	A*
Power consumption [W]	55	71	87	110	110	113	120	115	112	112
Water capacity [l]	70	80	80	125	125	170	170	280	280	280
Boiler weight [kg]	355	425	435	525	535	760	765	1090	1100	1110

* Composite label (boiler + controls)

Your Froling partner:



**Heizkessel- und Behälterbau GesmbH
A-4710 Grieskirchen, Industriestr. 12**

AUT: Tel +43 (0) 7248 606 • Fax +43 (0) 7248 606-600
GER: Tel +49 (0) 89 927 926-0 • Fax +49 (0) 89 927 926-219
Email: info@froeling.com • Internet: www.froeling.com

P0191517 - All illustrations intended as a guide only. We reserve the right to make technical changes without prior notice. Errors and omissions excepted. Sources for external images: www.propellets.at, www.aboutpixel.de