

**SP** DUAL

FIREWOOD AND PELLET BOILER



BETTER HEATING

INNOVATIVE AND  
COMFORTABLE

**froling** 



---

## ENVIRONMENTALLY RESPONSIBLE HEATING, ECONOMICALLY ATTRACTIVE

---



Wood pellets are made of natural wood. The large volumes of wood shavings and sawdust generated by the wood-processing industry are compacted and pelleted without being treated beforehand. Pellets have a high energy output and are easy to deliver and store. These are just some of the advantages that make pellets the perfect fuel for fully automatic heating systems. Pellets are delivered by tanker and unloaded directly into your store.

Wood is a domestic and environmentally friendly fuel that grows in large quantities, burns CO<sub>2</sub>-neutral and makes it independent of international trouble spots. In addition, numerous jobs are secured through the use of local wood. Therefore, wood is the optimal fuel from both an economic and an ecological point of view. There are different quality classes depending on the wood used.

For almost sixty years Froling has specialised in the efficient use of wood as a source of energy. Today the name Froling stands for modern biomass heating technology. Froling firewood, wood chip and pellet boilers are successfully in operation all over Europe. All of our products are manufactured in our factories in Austria and Germany. Froling's extensive service network ensures that we can handle all enquiries quickly.

---

## GUARANTEED QUALITY AND RELIABILITY FROM AUSTRIA

---

- International pioneer in technology and design
- Sophisticated fully automatic operation
- Excellent environmental compatibility
- Environmentally responsible energy efficiency
- Renewable and CO<sub>2</sub>-neutral fuel
- Ideal for all types of house
- Up to 5 year Froling-warranty (subject to warranty conditions)

### Two systems perfectly combined

The SP Dual firewood and pellet boiler combines two well designed systems. It fulfills all the requirements for firewood and pellet fuels in two separate combustion chambers. Highly efficient and convenient, the SP Dual guarantees low emissions and energy costs.

### Pellet unit can be added any time

The S4 Turbo F with pellet flange is the ideal solution for people who are currently only burning firewood. It can easily be converted to a dual fuel boiler by fitting the pellet unit at any time.

The „**Plus X Award**“ honours high-quality innovations that make life simpler and more enjoyable while respecting the environment. Froling's SP Dual stood out in the categories for **innovation, high quality, ease of use, functionality and ecology.**



# FIREWOOD AND PELLET BOILER SP DUAL

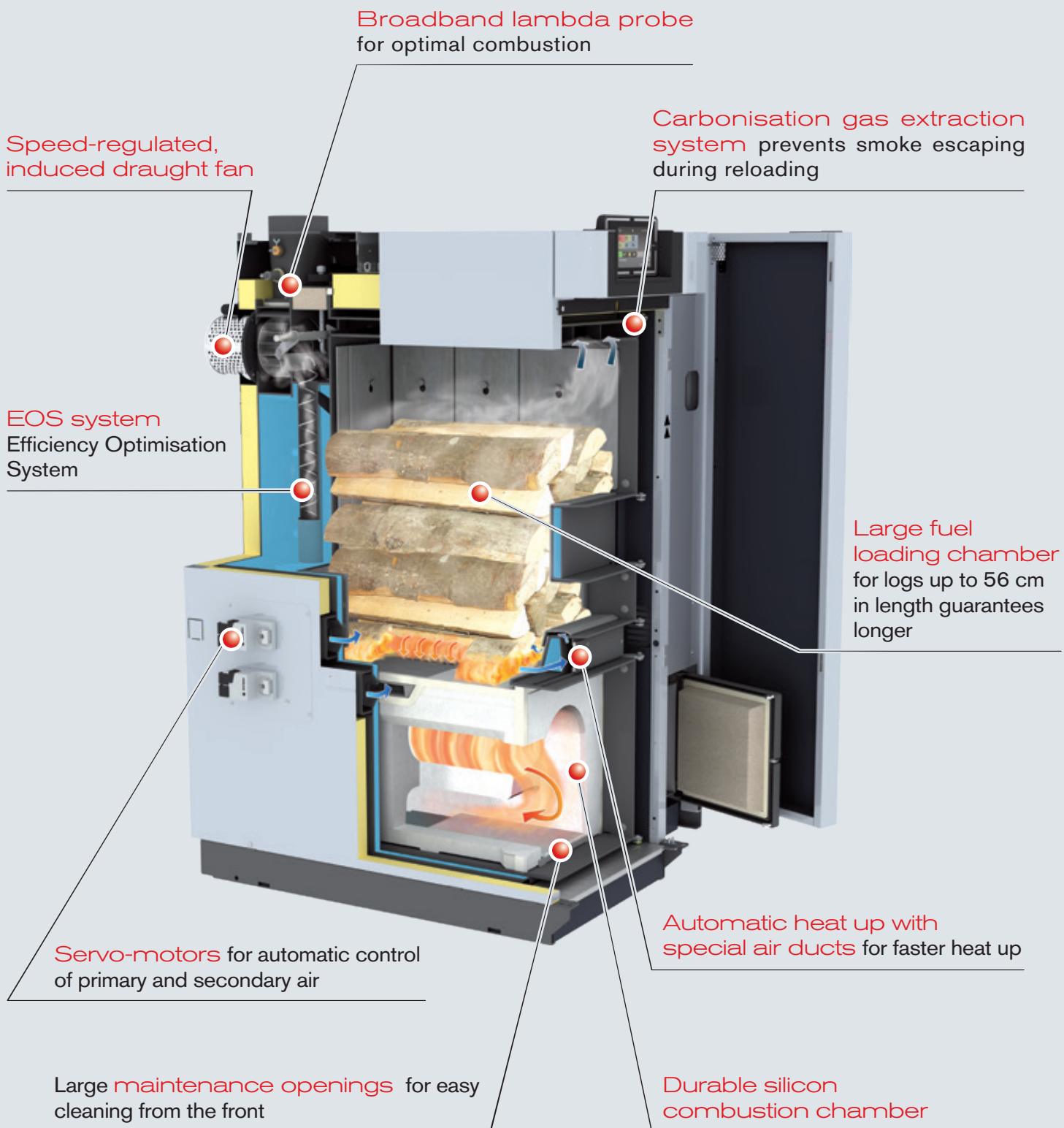





7" touch display for easy and intuitive operation

Double slide valve system for maximum burn back protection

Large fuel loading chamber doors for easy and convenient loading of firewood

Cladding to protect the inner wall of the boiler and for a longer service life

Spacious pellet container with stoker screw and external suction module

Water-cooled pellet flange with downward pointing design for safe operation

Fully insulated to minimize radiant heat loss

Practical, convenient ashcan for simple, dust-free emptying and long cleaning intervals

Water-cooled pellet burner with sliding grate for automatic ash removal and cleaning

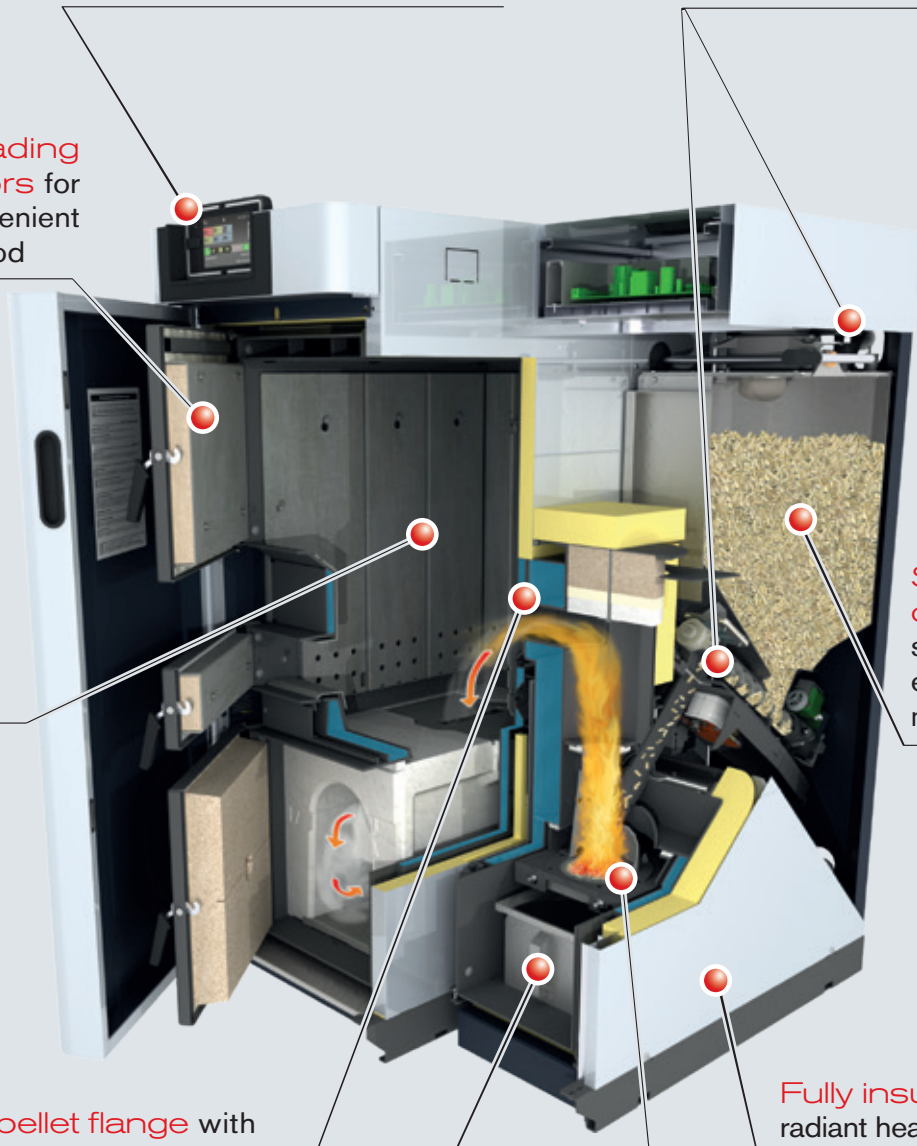

---

## A WELL- PLANNED INSIDE

---

### Large fuel loading chamber for logs up to 56 cm long with cladding

The SP Dual allows burning of firewood up to a length of 56 cm for all system output sizes. It is filled conveniently from the front of the unit and due to a large fuel loading chamber long refilling intervals are possible. Often it is only necessary to fill the boiler once a day. A cladding protects the interior walls of the boiler, guaranteeing a long service life.

- Advantages:
- Easy filling
  - Long lasting combustion
  - Long service life

### High-temperature silicon carbide combustion chamber with new geo- metric design

The combustion chamber is coated with a high-quality fireproof material (silicon carbide). Froling has refined the traditional cylindrically shaped combustion chamber and is setting new standards with an optimised heating gas duct. The exceptionally long combustion zone guarantees very low emissions.

- Advantages:
- Very long combustion zone
  - Low emissions
  - Long service life



---

## FOR MORE COMFORT

---

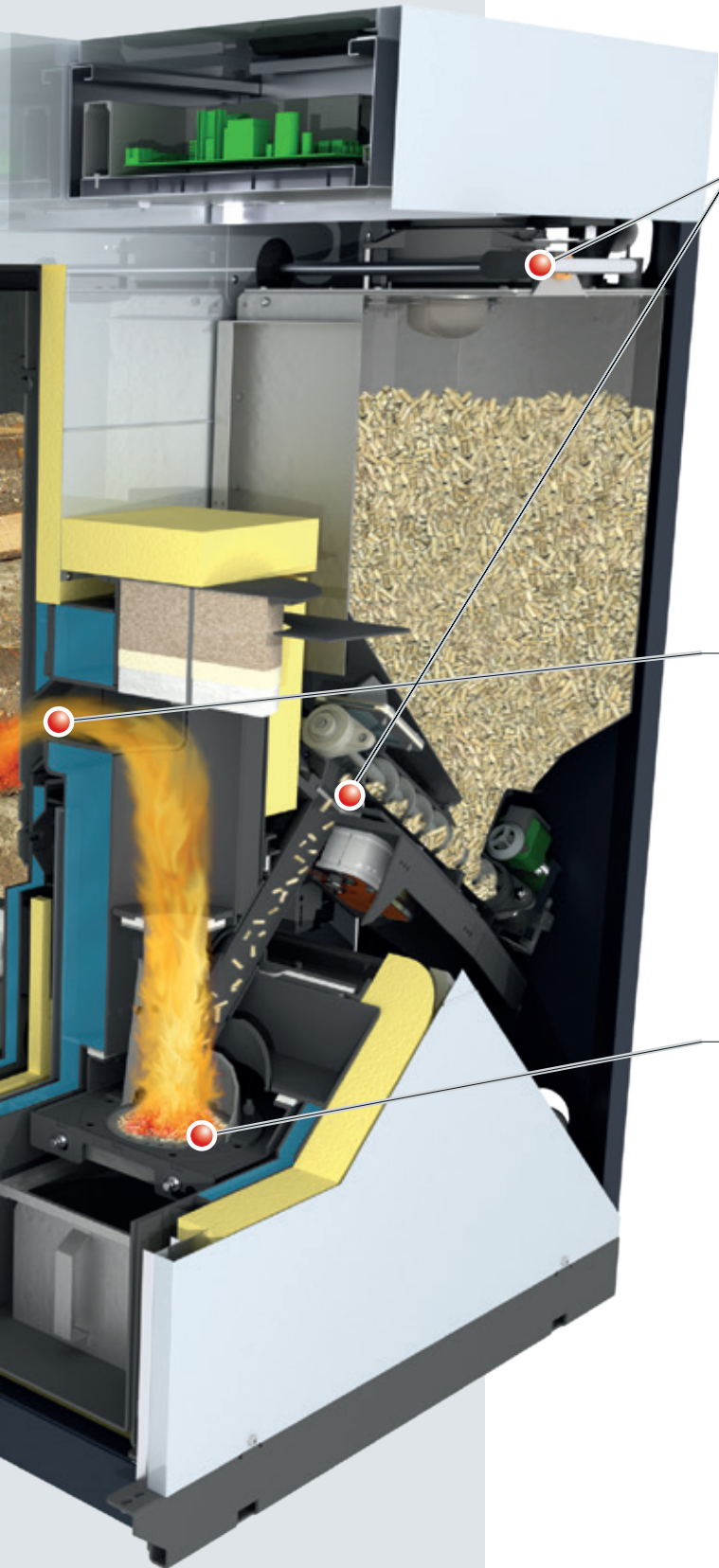

### Comprehensive safety concept

A double slide valve system - consisting of the burner gate valve in the downpipe and the store gate valves-guarantees maximum burn-back protection. A built in sensor measures the speed of flow in the combustion air during each phase of pellet combustion, guaranteeing safe operation.

- Advantages:
- The highest possible operating safety
  - Maximum reliability

### Water-cooled pellet flange pointing downward

The downward pointing design of the pellet flange ensures that no impurities from the filling room can reach the combustion grate of the pellet unit.

- Advantages:
- Safe operation
  - Pellet unit can be additionally fitted at any time

### Automatic ignition and continued operation

The firewood can be ignited automatically using the pellet burner.

Due to the separate combustion chamber design, it is possible to change between firewood and pellets when needed. When the firewood has burned down and is not replenished within a set period of time (0-24hrs), heating is automatically continued with pellets if required.

The SP Dual is designed to automatically interrupt pellet operation and to start firewood burning immediately when the loading chamber door is opened and filled with new firewood. The firewood can be ignited by the residual embers, manually or fully automatically using the pellet burner.

- Advantages:
- No additional equipping required
  - Automatic change between firewood and pellets



---

## INTELLIGENT DETAILS

---

### Speed-regulated induced draught fan

The speed-controlled induced draught fan is a standard component of the unit, which further enhances the reliability of the SP Dual. This means that the boiler can be started easily even if the chimney is cold. The speed regulation device in the induced draught fan stabilises combustion throughout the heating process and adjusts the output according to requirements.

- Advantages:
- Maximum ease of use
  - Problem-free boiler start
  - Constant stabilisation of combustion

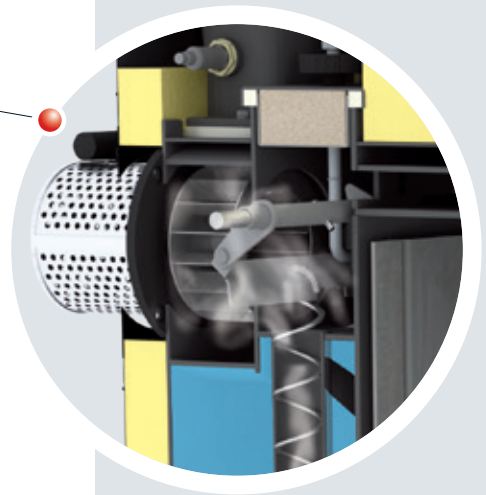

### Unique automatic heating-up (at manual ignition)

A unique design: The ignition door on the SP Dual can be closed immediately after ignition due to a special primary air duct. A striking difference to traditional systems. And to make life even easier, you can choose the optional automatic ignition. Heating with firewood can be so convenient!

- Advantages:
- Just load the boiler, light the fuel, close the door and feel the heat
  - The boiler room stays clean



### Special carbonisation gas extraction

The specialised carbonisation gas extraction system prevents smoke from escaping even while topping off during refill. This is applicable at every stage of combustion.

- Advantages:
- No smoke escapes during re-filling
  - The boiler room stays clean





## NEW! Optional with autom. EOS-Technik



### EOS system as standard

We never compromise on convenience. The EOS (Efficiency Optimisation System), which comes as standard on the SP Dual, consists of special turbulators, which are placed in the heat exchanger pipes. The lever arm mechanism ensures easy cleaning of the heating surfaces from the outside. An additional benefit of this mechanism is that it ensures higher efficiency and fuel savings.

- Advantages:
- Even more efficient
  - Easy cleaning from outside
  - Fuel economy



### Water-cooled pellet burner with automatic sliding grate

The water-cooled pellet burner is perfectly adapted to the fuel requirements enabling a particularly high level of efficiency. The sliding grate ensures automatic cleaning and ash removal into a large ashcan, thus ensuring convenient and maintenance-free operation.

- Advantages:
- High efficiency
  - Long lifespan
  - Automatic ash removal



### Convenient ash drawer

Easy handling is our main concern. The falling ash is fed automatically into a large ash drawer. Putting on the transport cover emptying can be done without spilling dust.

- Advantages:
- Long emptying interval
  - Convenient emptying

## 4 probe manual suction system

The RS 4 manual pellet suction system creates more space in your fuel store. Thanks to the fact that the suction probes are flexible in terms of location, it is possible to make optimal use of every room shape. The switchover between suction probes is manual. Rule of thumb: Plan for one suction probe for every 1 m<sup>2</sup> pellet storage area.



## Pellet filler pipes

The pellets are delivered by tanker and blown into the store through a filling pipe. The second pipe is used for controlled and dust free removal of the escaping air.

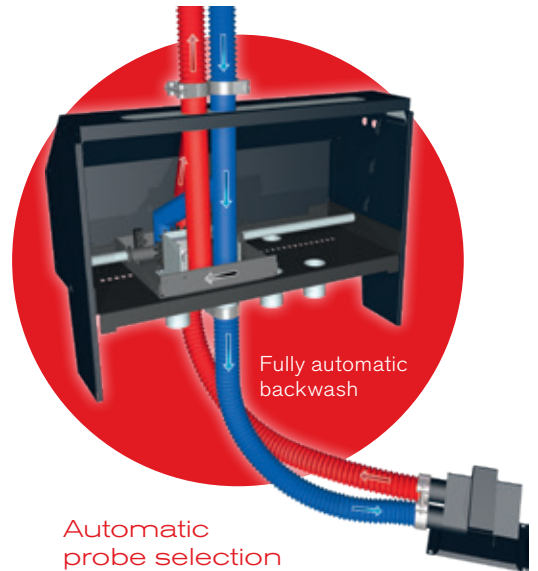

## Automatic probe selection

It automatically selects 4 or 8 suction probes in specified cycles, it is controlled by the pellet boiler. If, however, the suction probe fails unexpectedly, it is remedied by a fully automatic reversal of the air supply (back flushing).

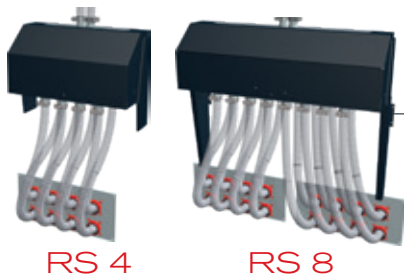

## Pellet suction system RS 4 / RS 8

Design as above, however with the difference of automatic switchover between the suction probes.



## Pyramid for fuel store optimisation

## Advantages at a glance:

- easy to assemble
- no sloping slides necessary in the bunker
- more store space (30%)
- automatic switching between the probes
- automatic back flushing
- maintenance-free system

More information can be found on the Froeling brochure "Discharge systems for pellets"

### Bag silo

The bag silo system is a flexible, simple way of storing pellets. Available in 9 different footprints (from 1.5 m x 1.25 m to 2.9 m x 2.9 m) with a capacity of between 1.6 and 7.4 tonnes, depending on the bulk density. There are other advantages to using a bag silo. It is easy to assemble and dustproof. You can also fit rainproof and sunproof covers and install the silo outside.



### Suction screw system

The Froeling screw suction system is the ideal solution for rectangular rooms with front-end removal. The deep and horizontal position of the discharge screw means the space in the room is used optimally and complete emptying of the store is guaranteed. Combined with a suction system from Froeling it also enables flexible boiler installation.



### Cube 330/500S pellet supply bin

The Cube 330/500S is the optimal and most cost-effective solution for low fuel requirements. Manually filled (e.g. pellets in sacks) it can store a total of 330 kg/495 kg of pellets. The pellets are transported to the boiler by means of a suction probe, which is also included in delivery.



### Pellet Mole®

This pellet discharge system is easy to install and makes full use of the store space. The Pellet Mole® draws the pellets from above, ensuring an optimum fuel feed to the boiler. The Pellet Mole moves automatically into every corner of the store to empty it as efficiently as possible.



# INDIVIDUAL CONTROL UNIT OF THE HEATING SYSTEM



## Lambdatronic S 3200 control unit

Fröling provides a future-oriented Lambdatronic S 3200 and a new 7" touch display. Intelligent control management makes it possible to connect up to 18 heating circuits, up to 4 storage tanks and up to 8 hot water storage tanks. The control unit ensures that the operating statuses are clearly shown. The menu structure is ideally organised to allow easy operation. All essential functions can be selected by simply pressing icons on the large colour display.

- Advantages:
- Precise combustion control by a Lambda control using a Lambda probe
  - Connection for up to 18 heating circuits, 8 water heaters and up to 4 storage tank management systems
  - Integration capability for a solar panel system
  - LED frame for status display with illuminated presence detection
  - Simple and intuitive operation
  - Various smart home options (such as Loxone)
  - Remote control from the living room (remote control 3200 and RGB 3200 Touch) or via Internet ([froeling-connect.com](http://froeling-connect.com))



# SIMPLE & INTUITIVE OPERATION

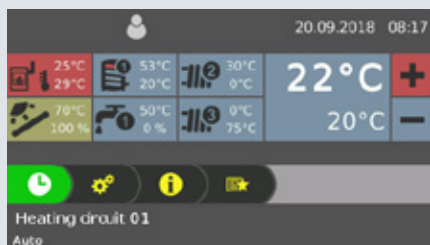

Fig. 1 General overview of the heating circuit (start screen)



Fig. 2 View of the heating times (individually adjustable)

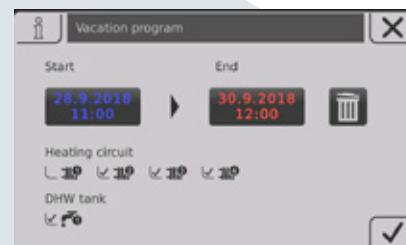

Fig. 3 Overview of the new holiday mode





---

## KEEP TRACK OF EVERYTHING WITH THE FROLING APP

---

The Froling App allows you to check and control your Froling boiler online from anywhere, at any time. You can read and modify the main status information and settings easily and conveniently online. You can also specify which status messages you want to be informed about via SMS or e-mail (e.g. when the ash box is to be emptied or in the event of a fault message).

Froling boiler (software core module from version V50.04 B05.16) with boiler touch display (from version V60.01 B01.34) a broadband internet connection and a tablet/smartphone with iOS or Android operating system are required. Once the boiler has been connected to the internet and activated, the system can be accessed 24/7 from anywhere using a web-enabled device (mobile, tablet, PC, etc.). The app is available in the Android Play Store and iOS App Store.

NEW! Desktop version  
with even more options.



- Simple and intuitive operation of the boiler
- Status information can be called up and changed within seconds
- Individual naming of the heating circuits
- Changes of status are notified directly to the user (e.g. via e-mail or push notifications)
- No additional hardware required (such as an Internet gateway)

---

## SMART HOME

---

Enjoy smart, convenient and piece-of-mind living with the Smart Home connection options from Froling.

---

### Loxone

---

Combine your Froling heating system with the Loxone Miniserver and the new Froling Extension and implement individual boiler control on the basis of the single room control of the Loxone Smart Home.

**Advantages:** Easy operation and viewing of the heating circuit via the Loxone Miniserver, immediate notification of status changes and individual operating modes for each situation (presence, holiday, economy mode, etc.)

---

### Modbus

---

Via the Froling modbus interface, the system can be integrated into a building management system.



# RELOAD CALCULATION FOR FIREWOOD

Efficient heating with intelligent reload calculation from Fröling. The current status of the system is visible at all times via the 7" touch display and can be used through simple parameterization of the storage tank type and the storage tank volume.

Taking into account the current storage tank charge, the boiler control calculates the missing energy. When the boiler door is opened, the required amount of fuel for loading the storage tank is displayed in kilograms.

## Wood types

Different types of wood with the same water content differ mainly in terms of weight. There are lighter (softwood) and heavy (hardwood) types of wood. In relation to weight, all types of wood have an almost identical heating value with the same water content.

In order to achieve the same heating value, more softwood is needed than hardwood. For customers who only have limited storage capacity, hardwood is therefore particularly suitable for heating.

Examples of softwood: spruce, fir, pine, larch, poplar, willow  
Examples of hardwood: oak, copper beech, ash, maple, birch, bird cherry

Display for softwood

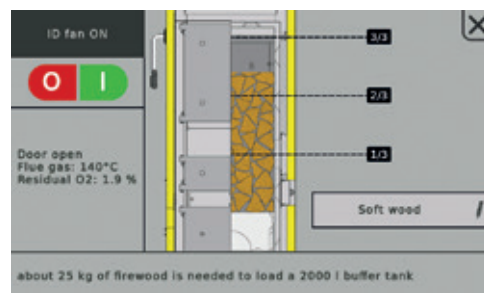

Display for hardwood

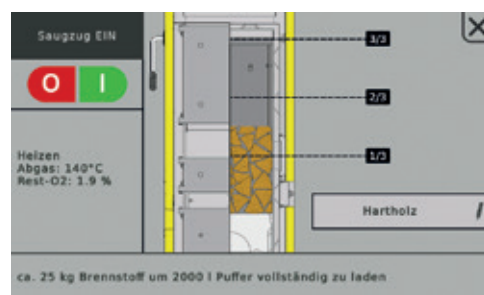

## Fröling tank systems with sensor strip

Fröling layered tanks have a terminal strip for optimal positioning of the sensors. This allows multiple sensors to be positioned at any height and moved without having to empty the tank. The labelling of the sensor strip and corresponding Fröling connection diagrams makes the sensors extremely easy to position and offer lots of different options.

To enable an exact calculation of the reload quantities, a total of 4 sensors (positions A, D, G, I) are attached to the terminal strip.

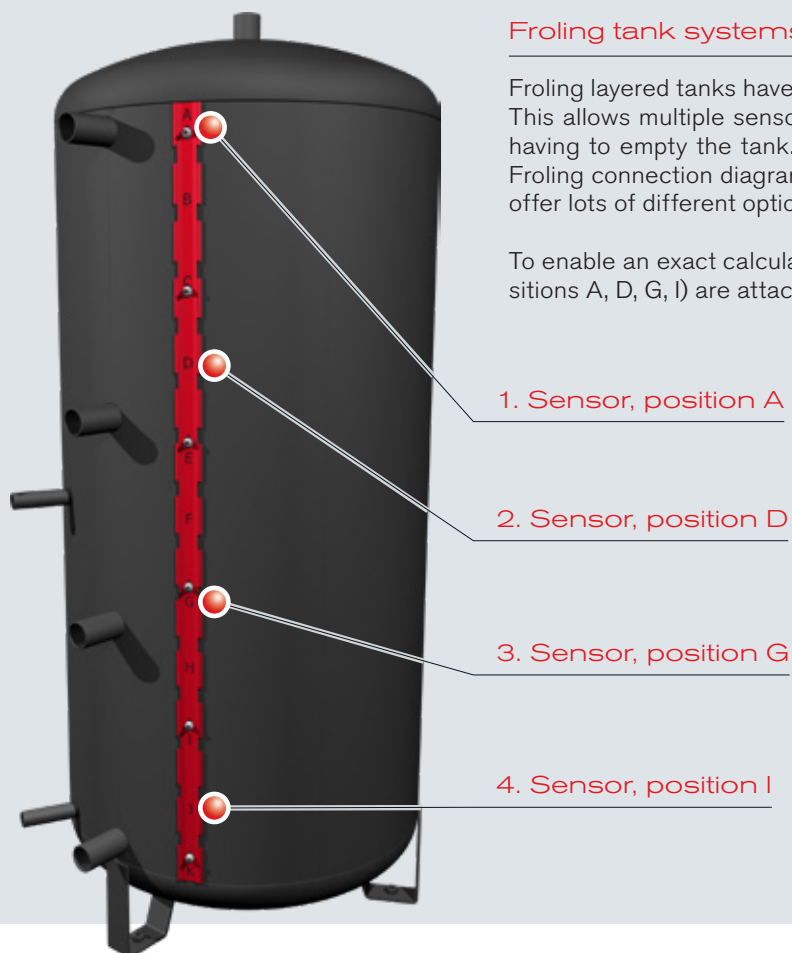

Correct positioning of the sensors on the terminal strip is crucial for optimal operation of the system!

---

## SYSTEM CONVENIENCE

---



FRA room temperature sensor

By using the just 8x8 cm FRA room temperature sensor, the main modes of the corresponding heating circuit can be easily selected and adjusted. The FRA can be connected both with and without affecting the store. The adjusting wheel allows you to change the room temperature by up to  $\pm 3^{\circ}\text{C}$ .



RBG 3200 room console

The RBG 3200 room console makes the system even easier to use. The heating system is conveniently controlled from your living room. All important system data is clearly displayed on the 19x8 cm console and settings can be changed at the push of a button.



RBG 3200 Touch room console

The RBG 3200 Touch has an impressive touchpad interface. The menu structure means it is intuitive and easy to use. The 17x10 cm console with colour screen shows the most important functions at a glance and automatically adjusts the background lighting to the conditions. The room consoles are connected to the boiler controller using a bus cable.



### Heating circuit

With wall housing and a contact sensor as heating circuit control for up to two mixer heating circuits.



### Hydraulic module

With wall housing and two immersion sensors for controlling one or two pumps and a changeover valve with up to six sensors.



### Solarpackage WMZ

Set for heat quantity measurement, consisting of a volume pulse generator ETW-S 2.5 one Collector sensor and two contact sensors for flow and return temperature measurement.

## SYSTEMS ENGINEERING FOR OPTIMUM ENERGY CONSUMPTION

Froling systems engineering offers efficient energy management. Up to 4 storage tanks, 8 hot water tanks and 18 heating circuits can help manage the heating. You can also benefit from the ability to integrate other means of energy production such as solar panel systems.

- Advantages:
- Complete solutions for all requirements
  - Components work perfectly together
  - Integrated solar power

### SP Dual with layered tank and Unicell

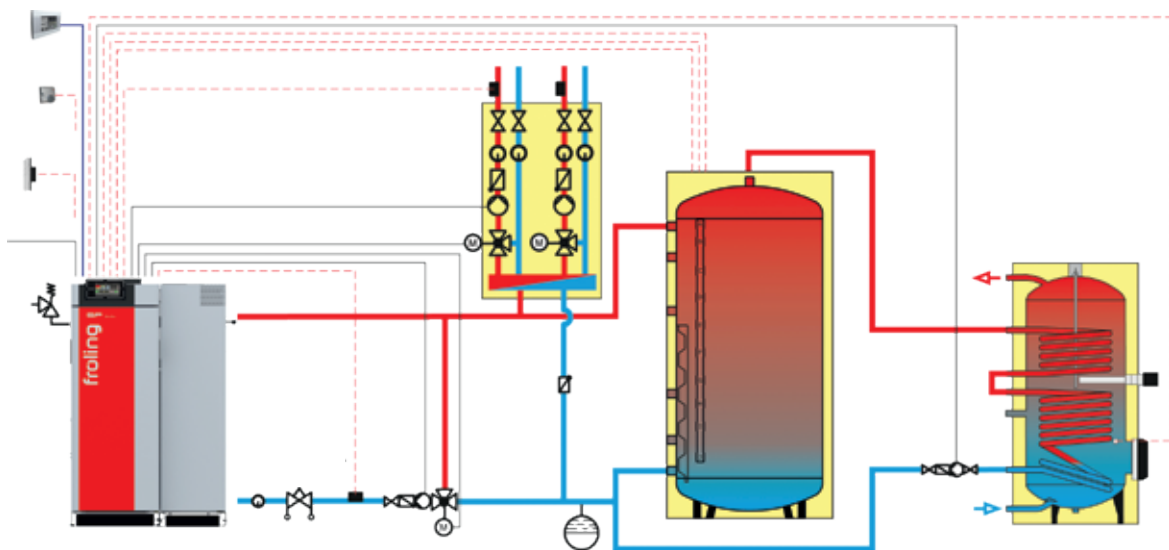



SP Dual with H3 and layered tank

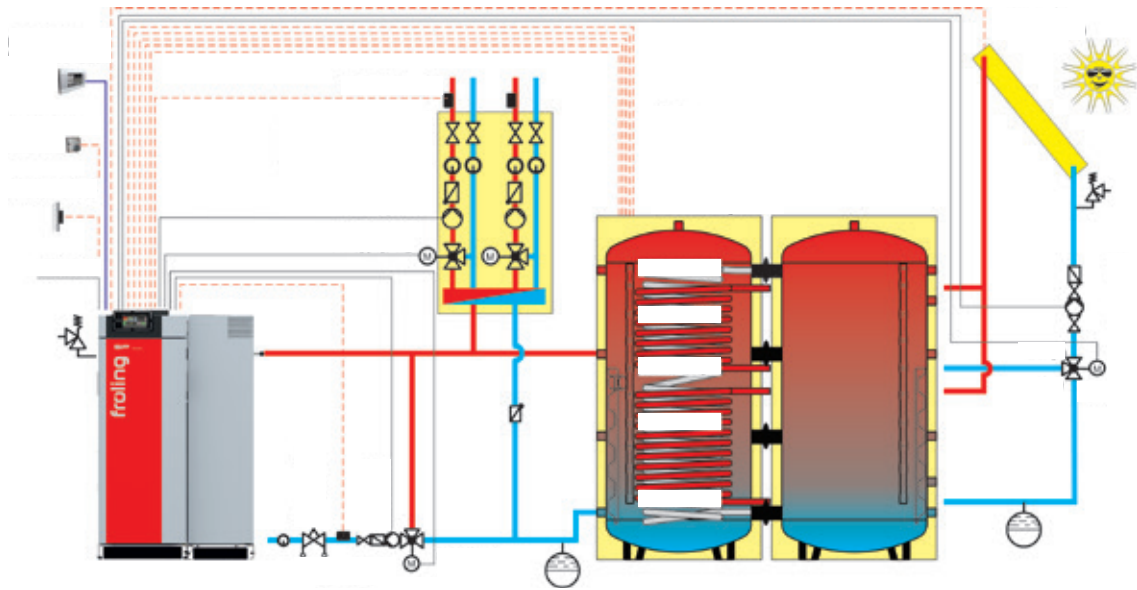

SP Dual with layered tank and hot water heat pump

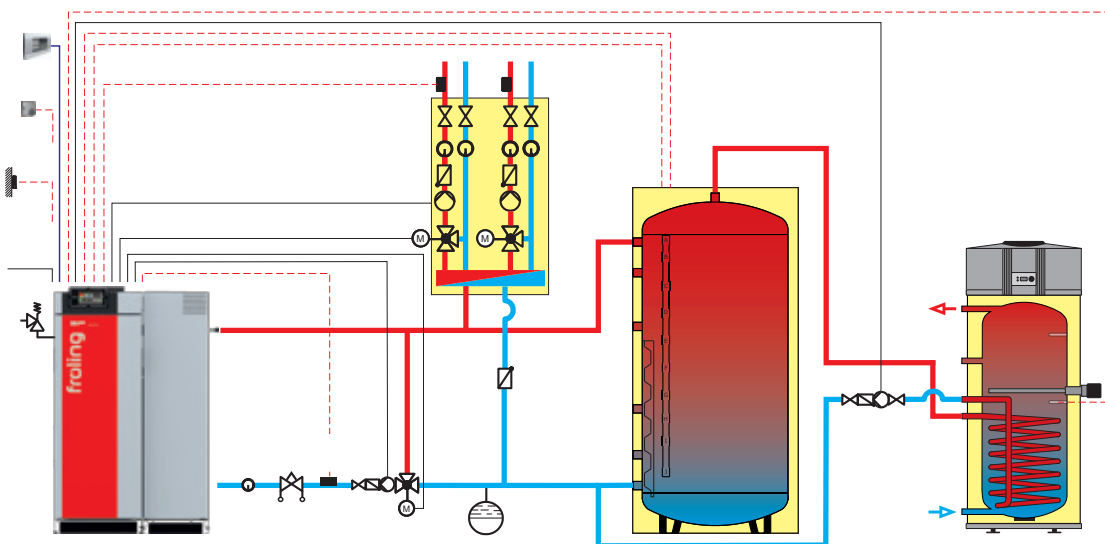

THE PERFECT COMBINATION

Please also see our "Tank systems" brochure.

# DIMENSIONS & TECHNICAL SPECIFICATIONS

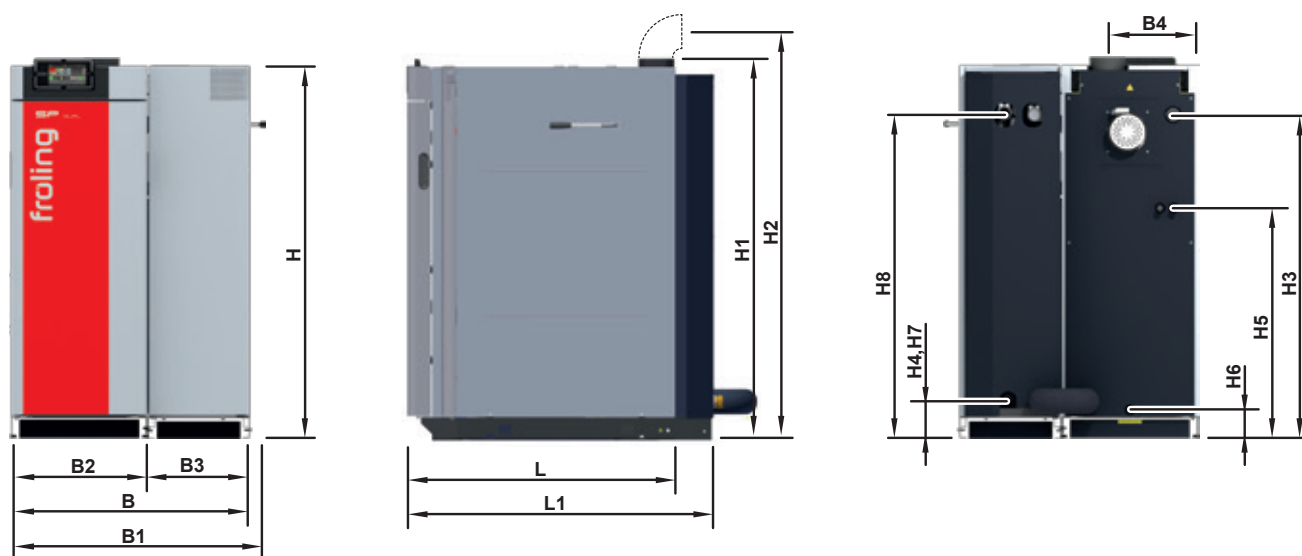

Dimensions - SP Dual [mm]	22	28	34	40
L Length, firewood boiler	1125		1215	
L1 Length, pellet unit	1285		1370	
B SP Dual width	1000		1100	
B1 Total width, SP Dual incl. heat exchanger lever	1060		1160	
B2 Width, firewood boiler	570		670	
B3 Width, pellet unit		430		
B4 Clearance from flue pipe connection to side of boiler	380		430	
H Height, boiler		1565		
H1 Total height including flue pipe nozzle		1595		
H2 Height flue pipe connection <sup>1</sup>		1700		
H3 Height, flow – firewood boiler connection		1360		
H4 Height, return – firewood boiler connection		140		
H5 Height, safety heat exchanger connection		970		
H6 Height, drainage connection		120		
H7 Height, flow and return - pellet unit connection	140		160	
H8 Height of suction system connection	1370		1360	
Flue pipe diameter		149		

<sup>1</sup> When using the optional flue pipe nozzle for low chimney connections

The ecodesign requirements according to VO (EU) 2015/1189, Annex II, point 1. are met.

Technical data - SP Dual	22	28	34	40
Nominal heat output - firewood operation / pellets operation [kW]	22 / 22	28 / 25	34 / 34	40 / 38
Heat output range - pellets operation [kW]	4,7 – 22	4,7 – 25	9,2 - 34	9,2 – 38
Energy (ErP) label <sup>1</sup>	A <sup>+</sup>	A <sup>+</sup>	A <sup>+</sup>	A <sup>+</sup>
Weight - firewood boiler / pellet unit [kg]	645 / 310	650 / 315	735 / 320	745 / 330
Water content - firewood boiler / pellet unit [l]	115 / 42		175 / 45	
Fuel loading door dimensions (width/height) [mm]	380 / 360			
Fuel loading chamber capacity [l]	145		190	
Pellet container capacity [l]	90		103	

<sup>1</sup> Composite label (boiler + controls)

## OPERATING AND MAINTENANCE AREAS

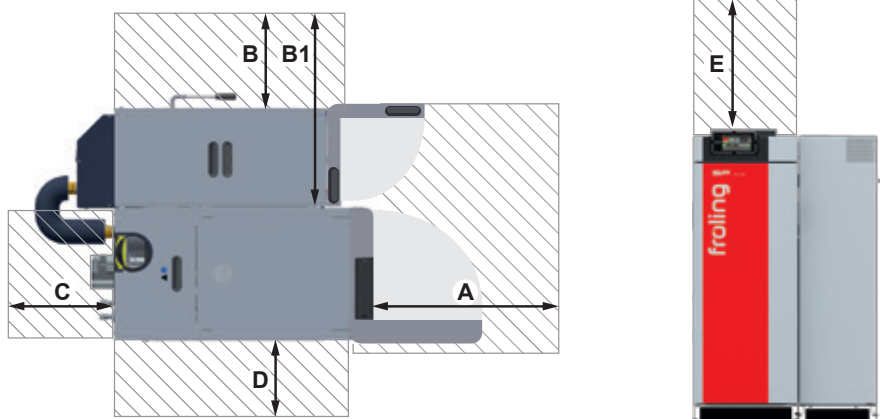

Minimum distances - SP Dual [mm]	22 / 28	34 / 40
A Distance – front of boiler to wall	800	
B Distance – boiler side with WOS lever and pellet unit to wall <sup>1</sup>	600 / 300	700 / 400
B1 Distance – boiler side without pellet unit to wall <sup>1</sup>	1030 / 730	1130 / 830
C Distance between rear of boiler and wall	500	
D Distance between side of boiler and wall <sup>2</sup>	200 / 800	
E Maintenance area to expand the WOS springs upwards <sup>3</sup>	500	

<sup>1</sup> When using the optional WOS drive or WOS lever on the left-hand side

<sup>2</sup> When using the WOS lever on the left-hand side

<sup>3</sup> Maintenance area to expand the WOS springs upwards



### Pellet boiler

PE1 Pellet	7 - 35 kW
PE1c Pellet	16 - 22 kW
P4 Pellet	48 - 105 kW



### Firewood boiler

S1 Turbo	15 - 20 kW
S3 Turbo	20 - 45 kW
S4 Turbo	22 - 60 kW

### Dual fuel boiler

SP Dual compact	15 - 20 kW
SP Dual	22 - 40 kW



### Wood chip / Large boilers

T4e	20 - 350 kW	TI	350 kW
Turbomat	150 - 550 kW	Lambdamat	750 - 1500 kW

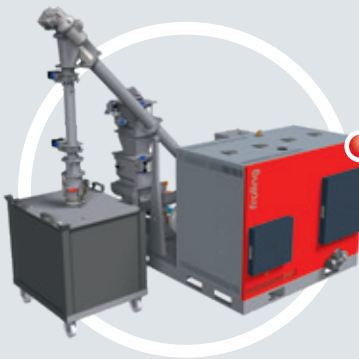

### Wood combined heat and power

Fixed-bed gasifier CHP	45 - 500 kWel
------------------------	---------------

Your Fröling partner

Fröling Heizkessel- und Behälterbau Ges.m.b.H.  
A-4710 Grieskirchen, Industriestr. 12

AT: Tel +43 (0) 7248 606-0  
Fax +43 (0) 7248 606-600

DE: Tel +49 (0) 89 927 926-0  
Fax +49 (0) 89 927 926-219

E-mail: [info@froeling.com](mailto:info@froeling.com)  
Web: [www.froeling.com](http://www.froeling.com)